

Sophos ES1100 Email Appliance Setup Guide

1. Preparation
2. Rack Installation
3. Appliance Rail Attachment
4. Cabling the Appliance
5. Software/Network Setup



Please read before proceeding

- This appliance is intended for installation in restricted areas only. Initial setup and maintenance should be performed by qualified personnel.
- Required operating conditions for the appliance are -
Temperature: 10 to 35°C. Humidity, non-condensing: 8 to 90%.
- Install and operate the appliance in a compatible rack only. Any other type of installation or use is not supported.
- To prevent the unit from overheating, never install the appliance in an enclosed rack or a room that is not properly ventilated or cooled. For proper airflow, keep the front and back sides of the appliance clear of obstructions and away from the exhaust of other equipment.
- Electrostatic Discharge (ESD) precautions are required before handling the appliance. Wear a wrist strap with an appropriate ground connection.
- Power down the appliance by pressing the power button. The appliance will safely shut down its software and the fans will stop. Remove the power cord before servicing the unit.
- Do not use mats designed to decrease static electrical discharge as protection from electrical shock. Use only mats that have been specifically designed as electrical insulators.
- Failure to properly ground the appliance, either by circumventing the 3-wire grounding-type plug or by using a power outlet that is improperly grounded, can create a potentially hazardous electrical situation.

1. Preparation

Unpacking the Appliance

Ensure that the ship kit includes two power cords, the correct number of screws and cage nuts (pictured below), and the 19-inch and telco-style rack rail assemblies (described below).

Rack screws and cage nuts (19-inch and telco-style)

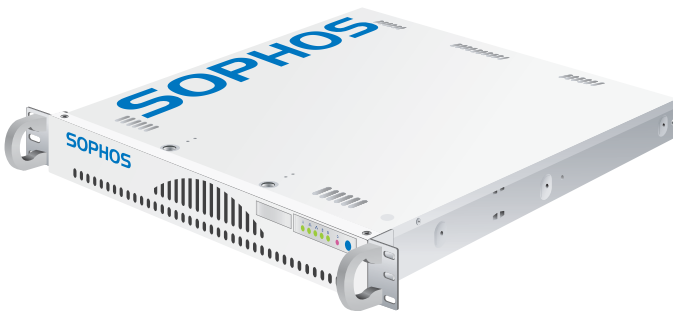
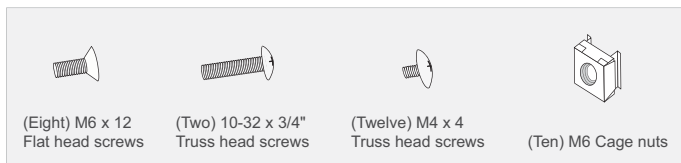

Both the 19-inch and telco-style rack assemblies consist of:

- (Two) long two-piece fixed chassis rails. During assembly, the inner rails are detached from the outer rail and fixed to the sides of the appliance. The outer rails are fixed directly to the rack.

The telco-style rack assembly consists of:

- (Two) medium, fixed brackets.
- (Two) short, fixed rack brackets.

19-inch and telco-style rack assemblies both include:

- (Two) medium, fixed rack brackets.
- (Four) short, fixed brackets that attach to the long rails. Two of these brackets have threaded holes for securing the appliance in the rack (as shown in step 2b).

Setup location

Make sure you have a laptop or PC that can later be connected to the rear of the appliance to complete the configuration.

- Choose a setup location with proper temperature control and adequate floor loading capacity for the current installation and for future growth.
- Install in or near appropriate AC outlets and Ethernet hubs or individual jacks (10/100 Base-T cables cannot be longer than 100 meters).
- Leave enough clearance, 65 cm (25 inches) in the front, and 75 cm (30 inches) in the back of the rack to provide access to appliance components and allow for sufficient airflow.

Rack and Appliance precautions

- **ALL RACKS MUST BE MOUNTED SECURELY.** Ensure that all leveling jacks or stabilizers are properly attached to the rack. If installing multiple appliances in a rack, make sure the overall loading for each branch circuit does not exceed the rated capacity.
- Do not slide more than one appliance out from the rack at a time. Extending more than one appliance at a time may result in the rack becoming unstable. Install your appliance in the lower part of the rack for improved weight distribution and easier access to appliance components.
- Always keep the rack's front door and all panels and components on the appliances closed when not servicing to maintain proper cooling.

2. Rack Installation

Step 1 (2a: 19-inch width rack)

Locate the two long fixed rack rails. Remove each inner rail by sliding it all the way to the right and pressing the locking tab to release it. You will attach the inner rails to the sides of the appliance in part 3, Appliance Rail Attachment.

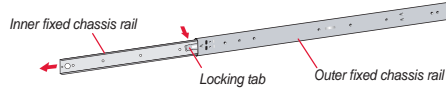

Step 2 (2a: 19-inch width rack)

Attach the medium (A) and short (B) brackets to the outer fixed chassis rails. Attach each short bracket by aligning the two holes at the back of the front bracket with the two threaded holes at the front of each chassis rail and securing with M4 x 4 screws. Attach each medium bracket by aligning the slots on the bracket with the threaded holes on the chassis rail. Adjust the medium brackets to suit the depth of the rack. Secure using two M4 x 4 screws for each bracket.

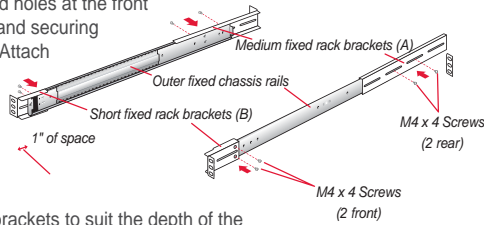

Step 3 (2a: 19-inch width rack)

Insert a cage nut into each square hole (three in the front and two in the rear for each rail). They click into place. Attach the rail/bracket assemblies to the rack using two M6 x 12 flat head screws at the front and rear. The middle cage nut at the front will be used later to secure the appliance in the rack. Make sure rail/bracket assemblies and screws are properly aligned at the front and back and are level in height on the left and right sides.

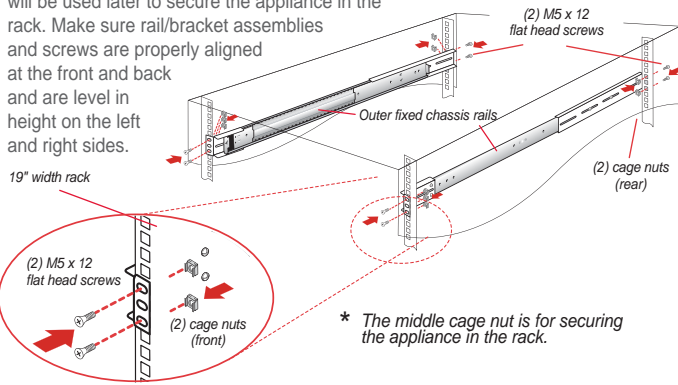

Step 1 (2b: telco-style rack)

Locate the two long fixed rack rails. Remove each inner rail by sliding it all the way to the right and pressing the locking tab to release it. You will attach the inner rails to the appliance in part 3, Appliance Rail Attachment.

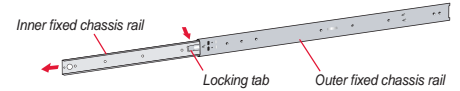

Step 2 (2b: telco-style rack)

Attach the medium (A) and short (B) brackets to the telco-style rack. Mount the short brackets in the front and the medium brackets in the back using two M6 x 12 flat head screws for the top and bottom holes of each bracket as shown. Make sure the brackets are aligned in the rack in the front and back and are level in height on the left and right sides.

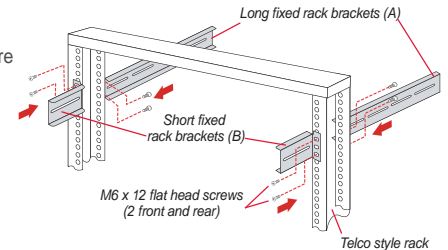

Step 3 (2b: telco-style rack)

Slide each of the outer fixed chassis rails into the left and right fixed brackets and loosely secure them with four M4 x 4 truss head screws on each side (See red dotted lines). Leave enough of the outer fixed rails extended in the front to loosely attach the threaded brackets (C) to the outer fixed rails using two M4 x 4 truss head screws on each side (See blue dotted lines). Once all four screws are in place, tighten each one to secure the outer fixed chassis rails.

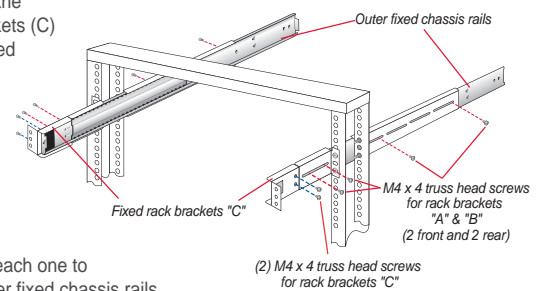

3. Appliance Rail Attachment

Step 1

Mount the inner fixed chassis rails on the appliance using three M4 x 4 truss head screws on each side.

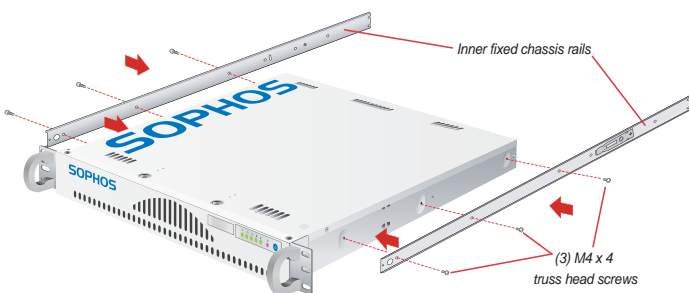

Step 2

Align the inner fixed chassis rails on the appliance with the fixed rack rails attached to the rack. Carefully slide the appliance into the rack until you hear the rails click into place. Push the appliance all the way back into the rack until it stops. Secure the appliance in the rack using two 10-32 x 3/4" truss head screws. Attach the screws to the center hole of each three-hole tab.

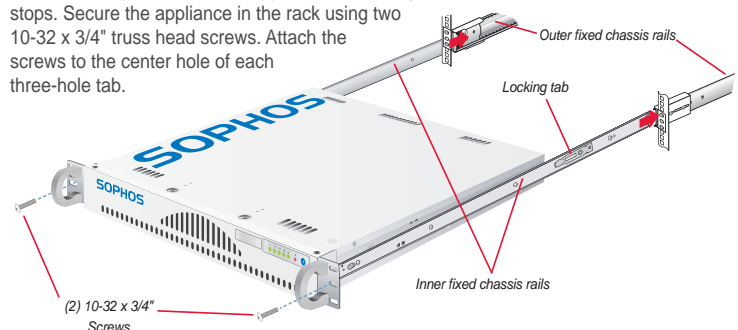

4. Cabling the Appliance

Rear connections

Do not connect the configuration interface (2) to your network.

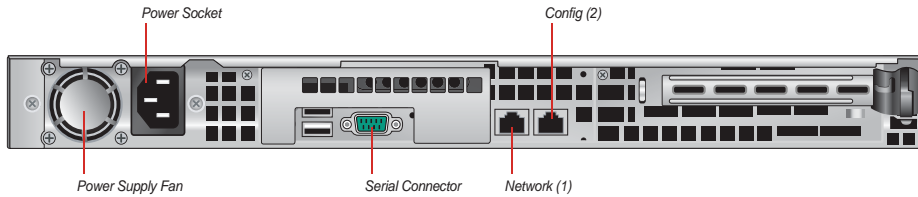

1. Connect power cord to the AC inlets.
2. Connect the [Network (1)] to your LAN.
3. Temporarily connect the [Config (2)] to your laptop using either an ethernet cable or a crossover network cable.
4. Press the power button to the right of the LEDs on the front of the unit.

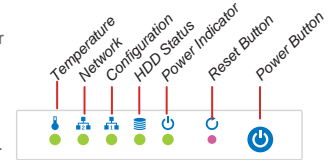

5. Software/Network Setup

Step 1 - Configure port access

Do not interrupt the installer once it begins. Doing so can damage the system to a point that it may require return to the factory to be re-imaged.

This Sophos Appliance uses specific ports for internal and external connections. Configure your network to allow access on the ports listed below. Some ports are required only for specific situations, such as when you enable directory services, or when the appliance is part of a cluster.

External connections

Port	Function	Service	Conn.	Purpose
22	Remote assistance	SSH	TCP	[Required] Between appliance and esa-ssh.sophos.com
25	Mail transfer	SMTP	TCP	[Required] Between appliance and internet/intranet
80	Software downloads	HTTP	TCP	[Required] Between appliance and internet
123	Network time synchronization	NTP	UDP	[Required] Between appliance and NTP server (e.g. pool.ntp.org)
443	Registration	HTTPS	TCP	[Required] Between appliance and esa-reg.sophos.com
444	Feedback	HTTP	TCP	Between appliance and sophos.com
10443/443	SPX secure web portal	HTTPS	TCP	Between appliance to internet (configurable)

Internal connections

20, 21	FTP backup	FTP	TCP	Between appliance and FTP server
24	Clustering	SSH	TCP/UDP	Between clustered appliances
25	Mail transfer	SMTP	TCP	Between clustered appliances
53	DNS services	DNS	UDP	Between appliance and DNS server
161	SNMP monitoring	SNMP	TCP/UDP	SNMP monitoring server(s) to appliance
162	SNMP traps	SNMP	TCP/UDP	Appliance to SNMP monitoring server(s)
389, 3268, (636, 3269)	Directory services synchronization	LDAP(S)	TCP	Between appliance and directory server
443/10443 (redirect from 80)	End user web quarantine	HTTPS	TCP	Between appliance and intranet (configurable)
5432	Database functions	ENCRYPTION SQL	TCP/UDP	Between clustered appliances
18080	Admin UI & clustered UI functions	HTTPS	TCP	[Required] Between appliance and intranet

Step 2 - Configure the Sophos Appliance

To configure the Appliance you will need the following:

✓	Activation code from Sophos
✓	Default gateway IP address
✓	DNS servers IP address
✓	Hostnames and DNS types for internal mail delivery servers
✓	Mail accepting domains
✓	IP addresses or hostnames of mail relays allowed to relay outbound mail through the appliance
✓	[Optional] Active Directory information (server, port, etc)

To launch the Sophos Appliance configuration wizard:

- On your laptop or PC, set the subnet mask to **255.255.255.0** and the IP address to **172.24.24.1**
- Using a supported browser, connect to **https://172.24.24.172**. You may need to add this address to your browser's Trusted Sites. When prompted, accept the certificate.
- Use the Configuration Wizard to set up your appliance.
Note: On the Network Interface page of the Configuration Wizard, the Speed option is set to Auto by default. If selecting another setting from the drop-down list, it must match the speed of your managed switch for the appliance to operate correctly.
- Disconnect the Ethernet or crossover cable from the Config (2).
Note: After setup is complete, administer your appliance via a web browser at <https://<Appliance-Hostname-or-IP>:18080>

You can view the online documentation at <http://sea.sophos.com/docs/sea>

Environmental Warning

Perchlorate Material - special handling may apply. See www.dtsc.ca.gov/hazardouswaste/perchlorate
This notice is required by California Code of Regulations, Title 22, Division 4.5, Chapter 33: Best Management Practices for Perchlorate Materials. This product/part includes a battery that contains Perchlorate material.

注意

この装置は、情報処理装置等電波障害自主規制協議会 (VCCI) の基準に基づき第一種情報技術装置です。この装置を家庭環境で使用すると電波妨害を引き起こすことがあります。この場合には使用者が適切な対策を講ずるよう要求されることがあります。